



**Electrolux**  
PROFESSIONAL

## Stainless Steel Preparation 373x2404 mm Aluminum Linear Units

ITEM # \_\_\_\_\_

MODEL # \_\_\_\_\_

NAME # \_\_\_\_\_

SIS # \_\_\_\_\_

AIA # \_\_\_\_\_



137026 (ALS2404)

Linear shelving set with aluminium side uprights and 4 polyethylene louvered shelves, 1120 Kg load, 373x2404 mm

### Short Form Specification

Item No. \_\_\_\_\_

For linear installation. 4-level shelving set with louvered sectional polyethylene shelves (depth=373mm). Aluminium (20 micron) side uprights (height=1700mm). Adjustable feet.

### Main Features

- Complete shelving system allows rapid and easy fixing of the shelves to the uprights.
- GN 1/1, GN 1/2 and GN 1/3 can be inserted into the frame.

### Construction

- Uprights and shelf frames constructed entirely in anodized aluminium (20 micron).
- Shelves made by section of polyethylene tablets.
- Sectional polyethylene shelves are dishwasher safe.
- 8 tiers.

### Optional Accessories

- Polyethylene shelf with aluminium frame, 373x1152mm PNC 850055
- Angle joint for shelves (depth=373mm) PNC 850070
- 2 swivelling wheels, 100mm PNC 850072
- 2 swivelling wheels with brakes, 100mm PNC 850073

APPROVAL: \_\_\_\_\_



Experience the Excellence  
www.electroluxprofessional.com  
professional@electrolux.com

Front

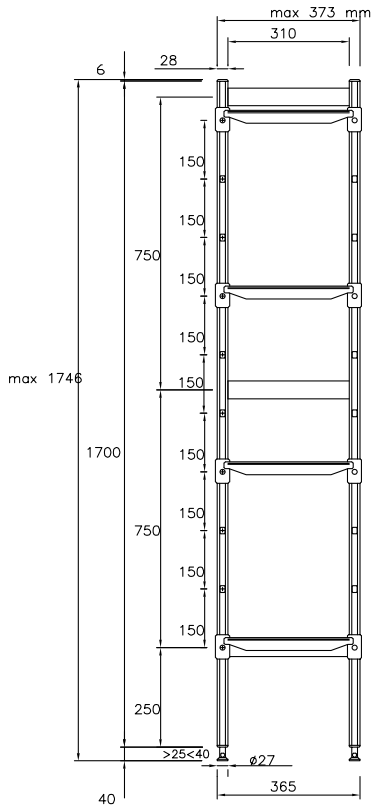

Top

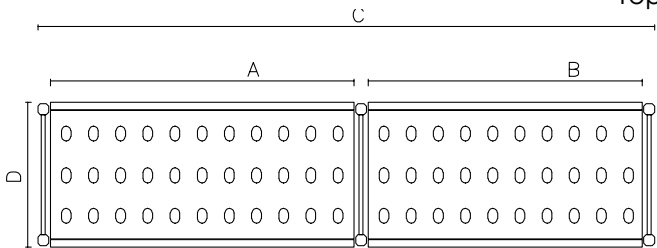

Other

	A mm	B mm	C mm	D mm
137019	708	798	1606	373
137020	798	798	1696	373
137021	798	886	1784	373
137022	886	886	1872	373
137023	886	974	1960	373
137024	974	974	2048	373
137025	1062	1062	2224	373
137026	1152	1152	2404	373
137027	1240	1240	2580	373
137028	1330	1330	2760	373
137029	1330	1505	2935	373

**Key Information:**

External dimensions, Width:	
137026 (ALS2404)	2404 mm
External dimensions, Depth:	373 mm
External dimensions, Height:	1700 mm
Max loading weight:	680 kg
Net weight:	39 kg
Uprights	3